



THM86/87 Industrial Multifunction Dew Point Transmitter



Application

〈 Feature 〉

- With temperature compensated and linear correction
- Physical quantity & temperature linear correction output by computer program
- Option : RS-485 interface and Modbus RTU protocol
- Option : quick metal connector to easy installation
- Industrial class sensor comes with high accuracy, long-term stability, and anti-condensation function.

〈 Application 〉

- Monitoring for storeroom / crisper / agriculture / food industry.
- Monitoring for industrial process / air conditioning/ environmental ventilation control .
- Temperature & humidity measuring in hospital / pharmaceutical industry/ textile industry.
- Environmental monitoring for building / factory / clean room / Lab / weather station.

Specification

Input

input	Capacitive Humidity Sensor & PT 100 Ω
measuring range list as below	

Output

output	0 ... 20 mA / 4 ... 20 mA / 0 ... 1 VDC / 0 ... 5 VDC / 0 ... 10 VDC
signal connection	3-wire
modbus	RS-485 (programmable)
linear accuracy (at + 25 °C)	temp. : $\pm 0.15 \text{ }^\circ\text{C} \pm 0.002 \text{ }^\circ\text{C} \times \text{tactical}$ dew point : $\pm 3 \text{ dp } ^\circ\text{C} \pm (0.02 \% \text{ F.S.} / ^\circ\text{C})$
temp. influence of body (at + 25 °C)	0.02 % F.S. / °C
load resistance	current output max. 500 Ω voltage output min. 10 K Ω
output calibration (ZERO & SPAN)	software
adjustment range	
response time t90	< 30S (SUS sintered filter) (temp. at +25 °C ; wind speed $\geq 1\text{m/s}$) < 20S (metal net filter)
display type	LCD Module with backlight, double line character
display range	upon request, 2 decimal place
height of character	5.56 mm

Environment

media measured	air
working temp. of body	-20 ... + 60 °C
working humidity of body	0 ... 95 RH % (non-cond.)
working temp. for LCD housing	0 ... 60 °C
working temp. of probe	-40 ... + 80 °C
storage temp.	-25 ... + 60 °C
Proof Pressure for probe	10 bar

Certification

CE certification	EN 61326-1:2006 · EN 61326-2-2:2006
Emissions	EN55011:2009 / A1:2010
Immunity	IEC 61000-4-2:2008 IEC 61000-4-3:2006 / A1:2007 / A2:2010 IEC 61000-4-8:2009

Electrical

power supply	8 ... 35VDC / 12 ... 30 VAC
current consumption	DC 24V : 60mA / DC 12V : 120 mA
electrical connection	AC 24V : 140mA / AC 12V : 230 mA M12 connector (4P or 8P)

Installation

installation	metal connector R1/2"
protection degree	body IP : 65 (probe : IP 20)
electric protection	⊙polarity protection ⊙over-voltage ⊙short circuit

Material

housing	Aluminum alloy
probe	stainless steel (SUS304) + PTFE
cable	teflon
option	fitting thread / metal mounting flange / shield metal grid filter without mesh
weight	THM86 : 521g THM87 : 635g

Measuring Range List

physical quantity	code	Min	Max	unit
temperature	T	-80	80	°C
dew point	D	-80	60	dp °C
frost point	F	-80	0	fp °C
absolute humidity	V	0	32767(analogue)	ppm/v
absolute humidity	G	0	32767(analogue)	ppm/w

※ frost point (F), absolute humidity-volume (V), absolute humidity-volume (G), please refer to the measured range list

Electric Connector

【 M type (M12-4PIN metal connector) 】 RS-485 or analogue

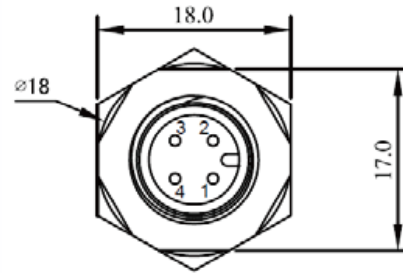
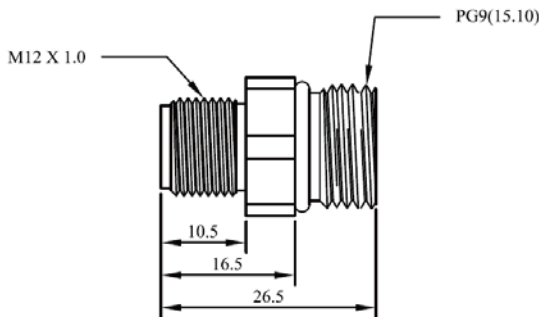

【 M type (M12-8PIN metal connector) 】 RS-485+analogue

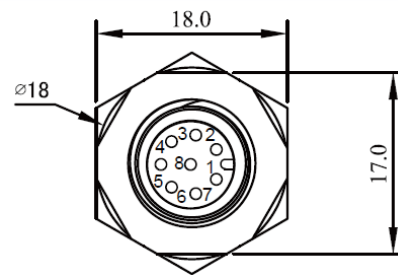

unit : mm

Analogue Diagram

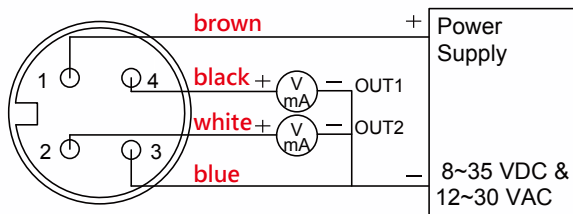

M12 connetor

M type (4P)

RS-485 Diagram

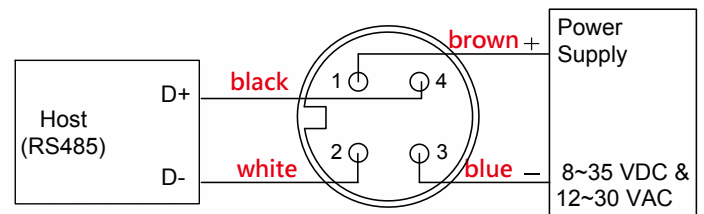

M type (4P)

Analogue + RS-485 Diagram

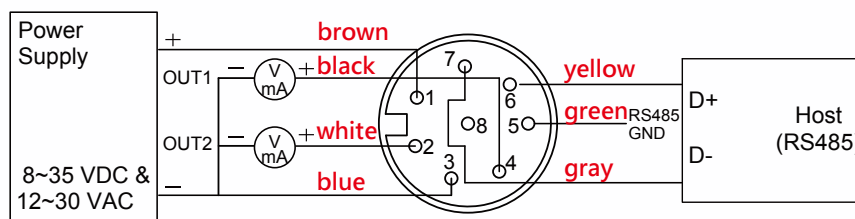

Q type (8P)

Dimension

THM86(duct)

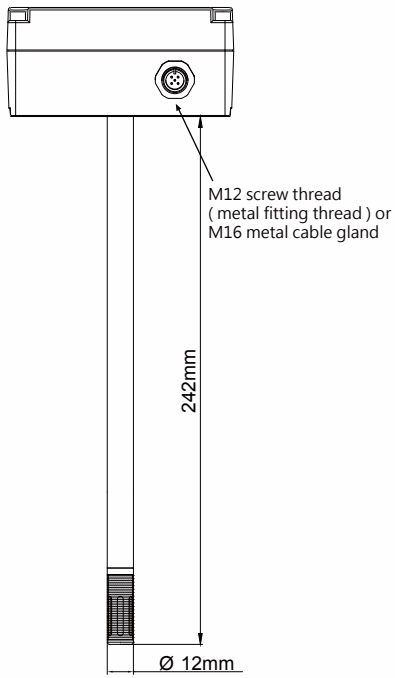

THM87(remote)

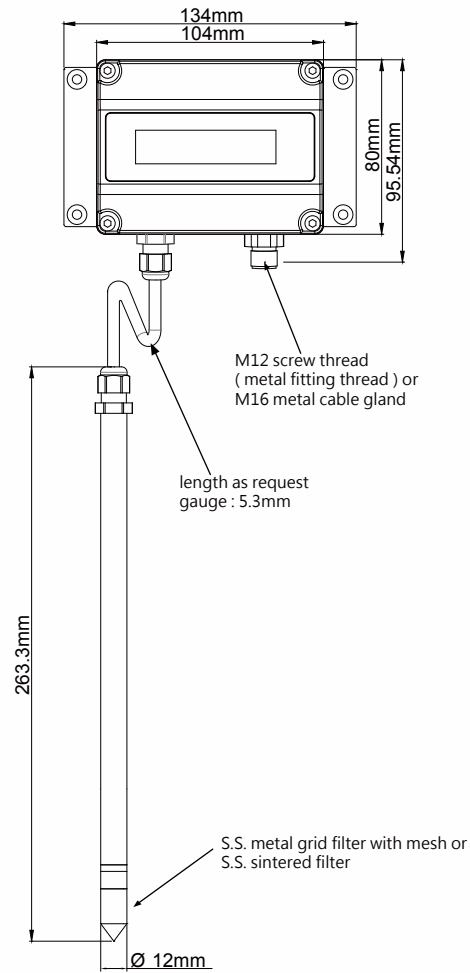

Ordering Guide

Type	THM	87	—	T	30	1	D	14	1	—	D	M	M	2
Installation	duct remote	86 87	— —											
Physical Quantity Output 1	temp. output dew point temp. frost point temp. absolute humidity (ppm / v) absolute humidity (ppm / w) RS-485 (default dew point) customize range			T D F V G N Y										
Physical Quantity Scale 1	-40 ... 80 °C 0 ... 50 °C 0 ... 80 °C -20 ... 40 dp °C -40 ... 60 dp °C -60 ... 20 dp °C -80 ... 20 dp °C -60 ... 60 dp °C as physical quantity range list customize range				20 30 38 13 14 17 19 60 00 YY									
Signal Output 1	4 ... 20 mA 0 ... 20 mA 0 ... 10V 0 ... 5V 0 ... 1V RS-485 customize range					1 2 6 7 8 9 Y								
Physical Quantity Output 2	temp. output dew point temp. frost point temp. absolute humidity (ppm / v) absolute humidity (ppm / w) RS-485 (default dew point) customize range			T D F V G N Y										
Physical Quantity Scale 2	-40 ... 80 °C 0 ... 50 °C 0 ... 80 °C -20 ... 40 dp °C -40 ... 60 dp °C -60 ... 20 dp °C -80 ... 20 dp °C -60 ... 60 dp °C as physical quantity range list customize range				20 30 38 13 14 17 19 60 00 YY									
Signal Output 2	4 ... 20 mA 0 ... 20 mA 0 ... 10V 0 ... 5V 0 ... 1V RS-485 customize range					1 2 6 7 8 9 Y								
Display	no yes										X D			
Electric Connector	M12 metal connector											M		
Filter	S.S. metal grid filter with mesh sintered filter												M S	
Remote Cable (max. length : 10 m)	2 m TEFLON cable 5 m TEFLON cable other length													2 5 —
Option / Other Request	other request (quote as demand) RS-485 + analogue													W U